







SLM-54F-V



Technische Daten / Technical data

Lichtfarbe color	Cw 	ww 	red 	green 	blue 	yellow 
Farbtemperatur Color temperatur	6000~7000K	2700~3300K	620~630nm	520~535nm	465~475nm	585~595nm
Lichtstrom Typ. Luminous flux lm	21±2	15.2±1	6,4±0.6	10.3±1	6,4±0.6	6,4±0.6
Betriebsspannung Working voltage	12V	12V	12V	12V	12V	12V
LED Leistung LED power	0.3W	0.3W	0.3W	0.3W	0.3W	0.3W
Schutzart IP code	IP65	IP65	IP65	IP65	IP65	IP65







- 3 x 3528 SMD LEDS
- Standardkabelänge / standard cabel length: 85mm
- Darf nur an eine Konstanzspannungsquelle mit 12V DC angeschlossen werden / only for use with 12V DC constant voltage power supply
- Max. Module in einer Kette / max. modules in one chain: 20
- Betriebstemperatur / Operating temperature: -30 bis / to +50 °C

Änderungen vorbehalten / Subject to changes

SLM-54F (Constant current design)



Technische Daten / Technical data

Lichtfarbe color	Cw 	ww 	red 	green 	blue 	yellow 
Farbtemperatur Color temperatur	6000~7000K	2700~3300K	620~630nm	520~535nm	465~475nm	585~595nm
Lichtstrom Typ. Luminous flux lm	21±2	15.2±1	6,4±0.6	10.3±1	6,4±0.6	6,4±0.6
Betriebsspannung Working voltage	12V	12V	12V	12V	12V	12V
LED Leistung LED power	0.3W	0.3W	0.3W	0.3W	0.3W	0.3W
Schutzart IP code	IP65	IP65	IP65	IP65	IP65	IP65





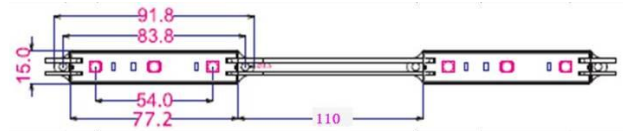

- 3 x 3528 SMD LEDs
- Standardkabellänge / standard cabel length: 85mm
- Darf nur an eine Konstanspannungsquelle mit 10-15V DC angeschlossen werden / only for use with 10-15V DC constant voltage power supply
- Max. Module in einer Kette / max. modules in one chain: 30
- Betriebstemperatur / Operating temperature: -30 bis / to +50 °C

Änderungen vorbehalten / Subject to changes

SLM-56F-V



Technische Daten / Technical data

Lichtfarbe color	Cw 	ww 	red 	green 	blue 	yellow 
Farbtemperatur Color temperatur	6000~7000K	2700~3300K	619~635nm	512~528nm	463~475nm	584~595nm
Lichtstrom Typ. Luminous flux lm	54±10%	45±10%	14,8±10%	36,0±10%	14,8±10%	14,8±10%
Betriebsspannung Working voltage	12V	12V	12V	12V	12V	12V
LED Leistung LED power	0.72W	0.72W	0.72W	0.72W	0.72W	0.72W
Schutzart IP code	IP65	IP65	IP65	IP65	IP65	IP65





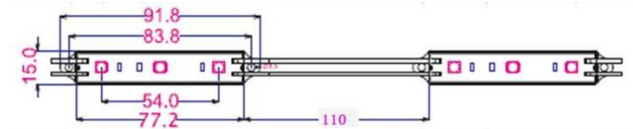

- 3 x 5050 SMD LEDS
- Standardkabelänge / standard cabel length: 110mm
- Darf nur an eine Konstanzspannungsquelle mit 12V DC angeschlossen werden / only for use with 12V DC constant voltage power supply
- Max. Module in einer Kette / max. modules in one chain: 20
- Betriebstemperatur / Operating temperature: -30 bis / to +50 °C

Änderungen vorbehalten / Subject to changes

SLM-56F (Constant current design)



Technische Daten / Technical data

Lichtfarbe color	Cw 	ww 	red 	green 	blue 	yellow 
Farbtemperatur Color temperatur	6000~7000K	2700~3300K	619~635nm	512~528nm	463~475nm	584~595nm
Lichtstrom Typ. Luminous flux lm	54±10%	45±10%	14,8±10%	36,0±10%	14,8±10%	14,8±10%
Betriebsspannung Working voltage	12V	12V	12V	12V	12V	12V
LED Leistung LED power	0.72W	0.72W	0.72W	0.72W	0.72W	0.72W
Schutzart IP code	IP65	IP65	IP65	IP65	IP65	IP65

- 3 x 5050 SMD LEDS
- Standardkabellänge / standard cabel length: 110mm
- Darf nur an eine Konstanspannungsquelle mit 10-15V DC angeschlossen werden / only for use with 10-15V DC constant voltage power supply
- Max. Module in einer Kette / max. modules in one chain: 30
- Betriebstemperatur / Operating temperature: -30 bis / to +50 °C

Änderungen vorbehalten / Subject to changes

SLM-SS1-RGB

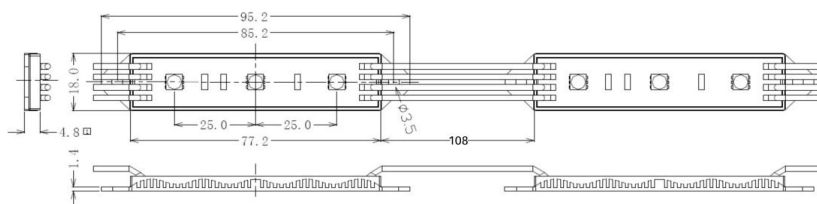
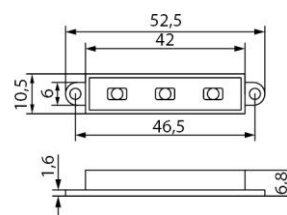

- Lichtstrom (Typ. Luminous flux lm) : R4,5lm G14lm B3lm,0.72w/pcs
- Betriebsspannung (Working voltage): 12V DC
- LED Leistung (LED power): 0,72W
- Schutzart (IP code): IP65
- Standardkabellänge / standard cabel length: 108 mm
- Max. Module in einer Kette / max. modules in one chain: 20
- Betriebstemperatur / Operating temperature: -30 bis / to +50 °C

Änderungen vorbehalten / Subject to changes

SLM-55F

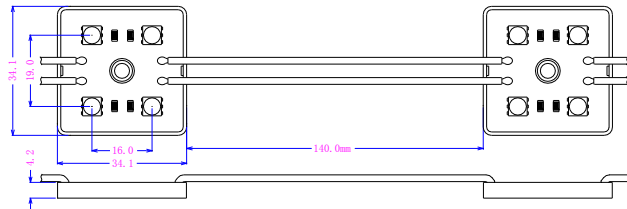

Technische Daten / Technical data

Lichtfarbe color	Cw	ww	red	green	blue	yellow
Farbtemperatur Color temperatur	6000~7000K	2700~3300K	620~630nm	520~530nm	465~475nm	588~595nm
Lichtstrom Typ. Luminous flux lm	72~88	64~80	18~24	48~64	9~12	16~20
Betriebsspannung Working voltage	12V	12V	12V	12V	12V	12V
LED Leistung LED power	0.96W	0.96W	0.96W	0.96W	0.96W	0.96W
Schutzart IP code	IP65	IP65	IP65	IP65	IP65	IP65







- 4 x 5050 SMD LEDS
- Gehäusematerial / material: Zink / zinc
- Standardkabellänge / standard cabel length: 140mm
- Darf nur an eine Konstantspannungsquelle mit 12V DC angeschlossen werden / only for use with 12V DC constant voltage power supply
- Max. Module in einer Kette / max. modules in one chain: 20
- Betriebstemperatur / Operating temperature: -30 bis / to +50 °C

Änderungen vorbehalten / Subject to changes

SLM-52F-V



Technische Daten / Technical data

Lichtfarbe color	Cw 	ww 	red 	green 	blue 	yellow 
Farbtemperatur Color temperatur	5500~6500K	2700~3300K	619~635nm	512~528nm	465~475nm	584~595nm
Lichtstrom Typ. Luminous flux lm	26	26	9	18	9	9
Betriebsspannung Working voltage	12V	12V	12V	12V	12V	12V
LED Leistung LED power	0.48W	0.48W	0.48W	0.48W	0.48W	0.48W
Schutzart IP code	IP65	IP65	IP65	IP65	IP65	IP65





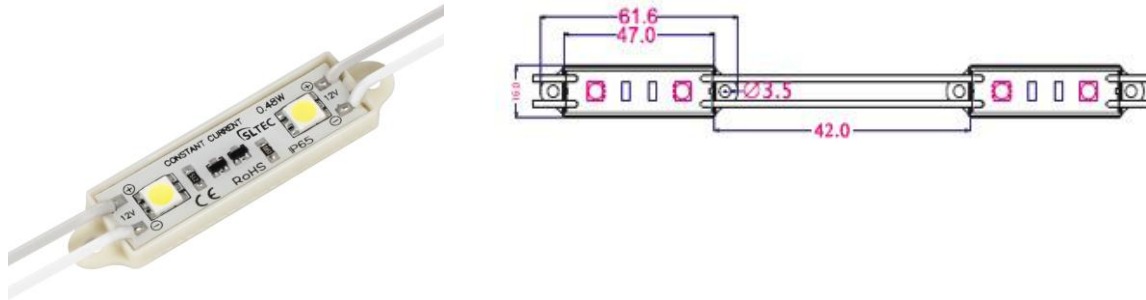

- 2 x 5050 SMD LEDS
- Standardkabellänge / standard cabel length: 42mm
- Darf nur an eine Konstanzspannungsquelle mit 12V DC angeschlossen werden / only for use with 12V DC constant voltage power supply
- Max. Module in einer Kette / max. modules in one chain: 20
- Betriebstemperatur / Operating temperature: -30 bis / to +50 °C

Änderungen vorbehalten / Subject to changes

SLM-52F (Constant current design)



Technische Daten / Technical data

Lichtfarbe color	Cw 	ww 	red 	green 	blue 	yellow 
Farbtemperatur Color temperatur	5500~6500K	2700~3300K	619~635nm	512~528nm	465~475nm	584~595nm
Lichtstrom Typ. Luminous flux lm	26	26	9	18	9	9
Betriebsspannung Working voltage	12V	12V	12V	12V	12V	12V
LED Leistung LED power	0.48W	0.48W	0.48W	0.48W	0.48W	0.48W
Schutzart IP code	IP65	IP65	IP65	IP65	IP65	IP65

- 2 x 5050 SMD LEDS
- Standardkabellänge / standard cabel length: 42mm
- Darf nur an eine Konstanspannungsquelle mit 10-15V DC angeschlossen werden / only for use with 10-15V DC constant voltage power supply
- Max. Module in einer Kette / max. modules in one chain: 30
- Betriebstemperatur / Operating temperature: -30 bis / to +50 °C

Änderungen vorbehalten / Subject to changes

SLM-59F

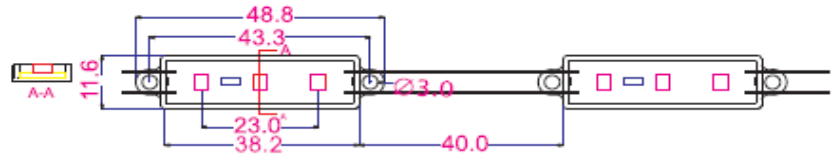

Technische Daten / Technical data

Lichtfarbe color	Cw	ww	red	green	blue	yellow
Farbtemperatur Color temperatur	5500~6500K	2700~3300K	620~630nm	520~535nm	465~475nm	585~595nm
Lichtstrom Typ. Luminous flux lm	21±2	21±1	6±0.4	15±1	6±0.4	6±0.4
Betriebsspannung Working voltage	12V	12V	12V	12V	12V	12V
LED Leistung LED power	0.3W	0.3W	0.3W	0.3W	0.3W	0.3W
Schutzart IP code	IP65	IP65	IP65	IP65	IP65	IP65





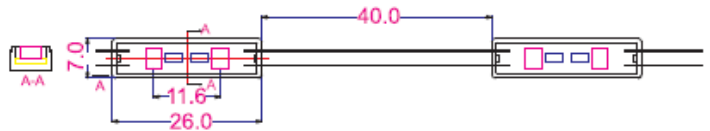

- 3 x 3528 SMD LEDS
- Standardkabelänge / standard cabel length: 40mm
- Darf nur an eine Konstanzspannungsquelle mit 12V DC angeschlossen werden / only for use with 12V DC constant voltage power supply
- Max. Module in einer Kette / max. modules in one chain: 20
- Betriebstemperatur / Operating temperature: -30 bis / to +50 °C

Änderungen vorbehalten / Subject to changes

SLM-71F



Technische Daten / Technical data

Lichtfarbe color	Cw 	ww 	red 	green 	blue 	yellow 
Farbtemperatur Color temperatur	5500~6500K	2700~3300K	620~630nm	520~535nm	465~475nm	585~595nm
Lichtstrom Typ. Luminous flux lm	14±2	14±2	4±0.6	10±1	4±0.4	4±0.4
Betriebsspannung Working voltage	12V	12V	12V	12V	12V	12V
LED Leistung LED power	0.3W	0.3W	0.3W	0.3W	0.3W	0.3W
Schutzart IP code	IP65	IP65	IP65	IP65	IP65	IP65





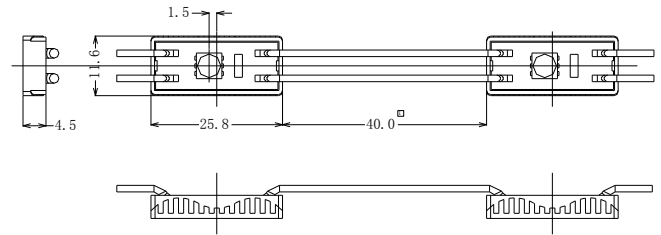
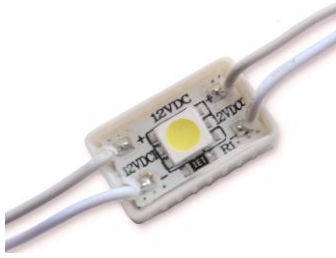

- 2 x 3528 SMD LEDs
- Standardkabellänge / standard cabel length: 40mm
- Darf nur an eine Konstantspannungsquelle mit 12V DC angeschlossen werden / only for use with 12V DC constant voltage power supply
- Max. Module in einer Kette / max. modules in one chain: 20
- Betriebstemperatur / Operating temperature: -30 bis / to +50 °C

Änderungen vorbehalten / Subject to changes

SLM-51F



Technische Daten / Technical data

Lichtfarbe color	Cw 	ww 	red 	green 	blue 	yellow 
Farbtemperatur Color temperatur	6000~7000K	3000~3500K	619~635nm	512~528nm	465~475nm	584~595nm
Lichtstrom Typ. Luminous flux lm	10	10	3,5	6	3,5	3,5
Betriebsspannung Working voltage	12V	12V	12V	12V	12V	12V
LED Leistung LED power	0.24W	0.24W	0.24W	0.24W	0.24W	0.24W
Schutzart IP code	IP65	IP65	IP65	IP65	IP65	IP65

- 1x5050 SMD LEDs
- Standardkabellänge / standard cabel length: 40mm
- Darf nur an eine Konstantspannungsquelle mit 12V DC angeschlossen werden / only for use with 12V DC constant voltage power supply
- Max. Module in einer Kette / max. modules in one chain: 20
- Betriebstemperatur / Operating temperature: -30 bis / to +50 °C

Änderungen vorbehalten / Subject to changes

SLM-160 (Constant current design)

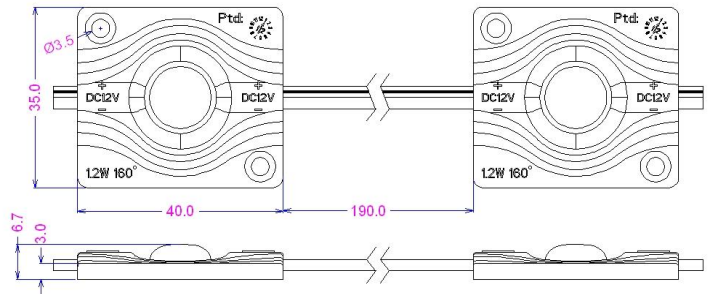

Technische Daten / Technical data

Lichtfarbe color	Farbtemperatur Color temperatur	Lichtstrom Typ. Luminous flux lm	Betriebsspannung Working voltage	Betriebsstrom Rated current	LED Leistung LED power	Schutzart IP code
Cool white	6000~7000K	100 Lm	12V	100mA	1,2 W	IP 67

- **Abstrahlwinkel / Beam angle: 160°**
- Power LED
- Standardkabelänge / standard cabel length: 190mm
- Darf nur an eine Konstantspannungsquelle mit 12V DC angeschlossen werden / only for use with 12V DC constant voltage power supply
- Max. Module in einer Kette / max. modules in one chain: 30
- Betriebstemperatur / Operating temperature: -30 bis / to +50 °C

Änderungen vorbehalten / Subject to changes